

Buildings cost less with the

Simple Saver System[®]

The #1 specified high R-value insulation system for metal buildings



Over 40,000 installations since 1983

Thermal Design's
liner systems
reduce these costs:



Featuring superior
JM Formaldehyde-free[™]
fiber glass insulation

Table of contents:

HVAC

Lighting

Electrical

Finishes

Utilities

Erection



2	Simple Saver System
3	Johns Manville Insulation
4	New Roof Construction
6	New Wall Construction
8	Common Uses
10	Retrofit Roof & Walls
12	Safety & Fall Protection
13	Performance
14	Simple Saver Synergy Design SM
16	Performance Guarantee

Simple Saver System®

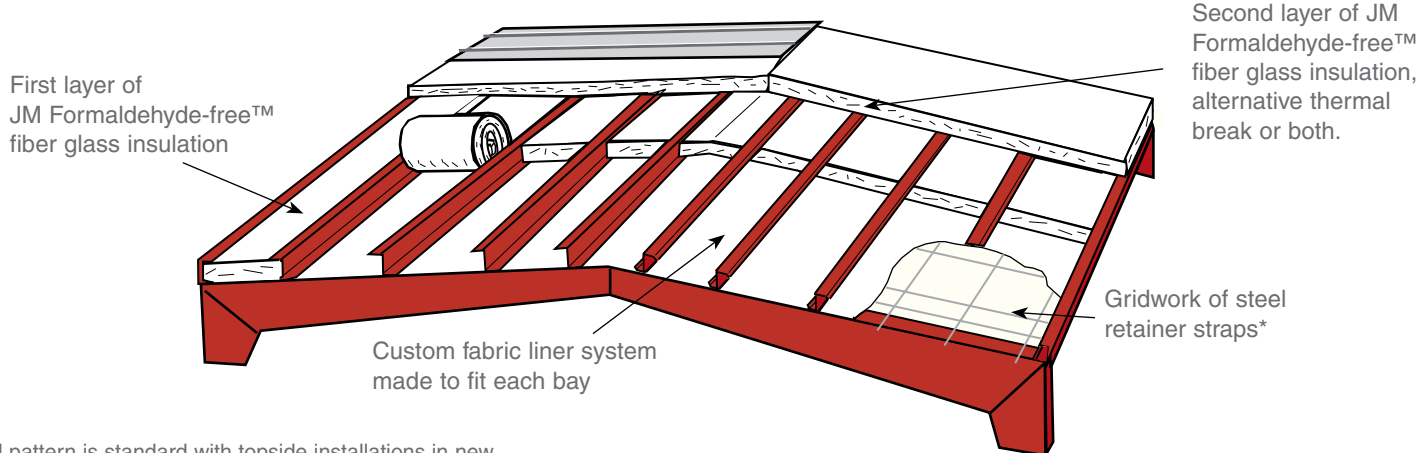

*A grid pattern is standard with topside installations in new buildings. Retrofit standard strap pattern is single direction.

System components are sold as a designed package and not sold separately.

Superior Insulation System

The Simple Saver System is designed to create the average depth space needed for the full specified insulation thickness plus deflection and deliver the maximum possible insulation performance. Conductive structural members penetrating through the insulation require thermal breaks and may reduce overall performance. Properly sealed ceiling and wall systems prevent air infiltration and isolate the conductive steel structure from the conditioned space air. **The Simple Saver System provides both low U-values and low emissivity values, stopping over 90% of all three types of heat transfer.**

Engineered Strength for Safety – FREE

The Simple Saver roof liner system is engineered to be strong and durable for job site safety, is OSHA Compliant and a patented fall arrest system. The super strong liner system withstands the rigors of installation and provides workers beneath with protection from falling objects. The liner system then permanently supports the insulation. This limits the liability of owners, designers and contractors (Standard 29 CFR Definitions–1926.751 "Controlling Contractor").

The fall protection benefits are free, but only with the legitimate, patented Simple Saver System (Patent # 5901518).

Class A Fire Safety Rating – FREE

The vapor retarder fabric liner of the standard Simple Saver System is **self-extinguishing** as it complies with: ASTM 1136, Types I through VI; NFPA 701 Large Scale; flame spread of 25 or less per ASTM E-84 (equivalent to NFPA 255, ANSI 2.5 or UL/ULC 723). Special order or modified products may be tested upon order by the purchaser for the costs of the tests.

Absorbs Sound – FREE

Provides excellent yet inexpensive acoustic finishes where conventional suspended ceilings are not appropriate or not in the budget. Standard system has **75% sound absorption** (NRC 0.75). This superb by-product of the Simple Saver System comes free with the system. Excellent for gymnasiums, arenas, houses of worship, manufacturing, entertainment spaces and multipurpose rooms.

Finishes and Decorates – FREE

The Simple Saver System's free, **bright white appearance** is often used as an exposed interior finish in buildings. Purlins and girts are hidden, eliminating the cost to paint them. Various colors and strap patterns may be specified to obtain unique aesthetic appearances. The ceiling and wall surfaces are washable and easy to maintain.

Brightens Interiors – FREE

The bright white, light reflective surface enhances efficiency of the lighting system, **eliminating about 30% of the number of light fixtures**. Light reflectance tests of up to 85% are achieved. Savings of lighting equipment, wiring and electricity result in substantial dollar savings for the building owner. Low ultraviolet producing light sources or UV filtered lenses are necessary to prevent UV degradation and obtain optimum service life.

Helps Prevent Condensation – FREE

The high strength Simple Saver fabric liner isolates the cold conductive purlin and girt surfaces from the inside conditioned air, reducing the exposed conductive purlin and girt surface areas from about 50% of the roof and wall areas to a fraction of 1%. Water vapor transmission rate is ≤ 0.02 grains per hour/sq. ft. for the standard fabric liner. **Factory-made, triple extrusion welded seams are for safety and uniquely pressure resistant to assure the very low vapor permeance and vapor retarder integrity** as opposed to thousands of staple holes or hidden, unsealed lap joints typical with laminated insulation.



JM Formaldehyde-free™ fiber glass insulation			
Thickness	Pre-Installed R-Value	Width* (in)	Length
9"	R-30	48 • 60	35'
8"	R-25	48 • 60	40'
6"	R-19	36 • 48 • 60 • 72	50'
4"	R-13	36 • 48 • 60 • 72	75'
3 1/2"	R-11	48 • 60 • 72	75'
3"	R-10	36 • 48 • 60 • 72	100'

*Other cut sizes available.

Some minor wrinkles may be visible due to the large pieces of support fabric used.



Superior Recovery with Less Itch and Less Dust

Fiber glass insulation is made of two things: glass and a binder. The binder glues the thin glass threads together. This is “bonded” fiber glass insulation, found in batts and rolls. Other manufacturers use formaldehyde in their binder. JM Formaldehyde-free™ fiber glass insulation utilizes an innovative acrylic binder that eliminates binder-related formaldehyde emissions.

The U.S. Environmental Protection Agency recommends limiting exposure to formaldehyde as much as possible.

Source: Environmental Protection Agency

When installers open the packaged insulation rolls, they quickly notice two things; superior recovery and the fiber glass is virtually odorless. JM Formaldehyde-free™ fiber glass insulation uses high quality glass in their manufacturing process which benefits installers with less dust and less itch during and after installation.

Once installed, it will not “off-gas” formaldehyde in the indoor environment. That means formaldehyde won't leak from the insulation in your walls and ceilings. Formaldehyde is added to many other building products, it makes sense to use products without it whenever possible.



Product Description

PEBS Blanket™ and Microlite® "L" are general purpose fiber glass insulation blankets made without formaldehyde for use in both roofs and walls of pre-engineered metal buildings, post frame buildings, joist buildings and other structure types.

Specification Compliance

ASTM C 991, Type I / ASTM E 136 / ASTM E 84
Flame Spread Classification of 25/50 or less flame spread/smoke developed rating.

Fresh Insulation

JM Formaldehyde-free™ fiber glass insulation is shipped from the manufacturer directly to the job site. Insulation rolls are carefully packaged for savings in freight, ease of handling, protection of quality and have excellent recovery once opened on site.

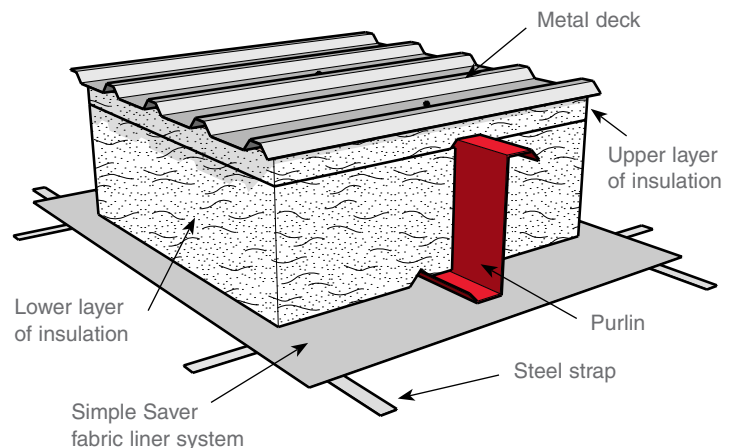

Strapping – Simple Saver System uses corrosion resistant, 1” wide x .020 UVMAX® strapping that is twice as strong with a dependable 100,000 lbs /square inch tensile strength. Strapping is color matched to the fabric and ships in 1,500 ft. oscillated wound coils. Each installed strap is continuous, no field splicing is needed.

Fasteners – Simple Saver fasteners have sealing washers and are color matched to the fabric liner system. Available in multiple types and sizes depending upon the substrate type.

Syseal® Tapes & Sealants – Thermal Design has formulated special products for fast application and the optimal seal strength of the Simple Saver fabric liners.

Fabric Liner

The UVMAX® coated fabric is a proprietary woven, high density polyethylene fabric which provides a Class A fire retardant rating. Our UVMAX® white maximizes total light reflectivity. The fabric liner can also be perforated for unique building conditions. The durable Simple Saver fabric liner is over 300% stronger than typical metal building insulation facings. **Request a free sample!**

White or
Super White

Black

Silver Aspen

Toni Taupe™

Other Colors
Available

Specific fabric color may not be an exact match of the examples show above.

New Roof Construction

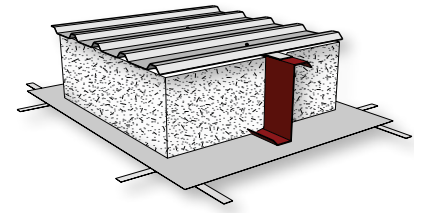
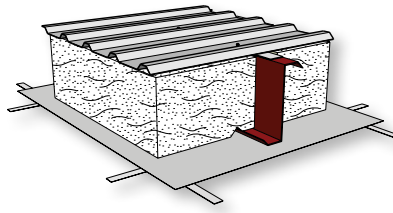
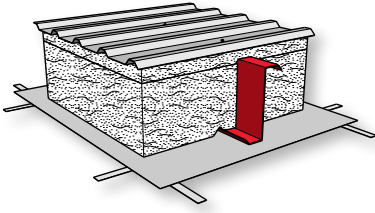

Thermal spacer blocks may be added to increase insulation space and further reduce conduction.

Double Layer Systems

The upper layer of fiber glass is installed between roof decking and the structure to reduce thermal conduction.

Single Layer Systems

Thermal breaks are recommended between roof decking and the structure to reduce thermal conduction.

Blown-in Systems

Blown-in systems fill nearly every crack and crevice for maximum thermal performance.

The Simple Saver System[®] is a patented fabric liner system that minimizes insulation compression and isolates the conductive purlins from the inside conditioned air.

The Simple Saver fabric liner system is custom made for each order and the Syseal[®] fabric liner typically spans the entire bay's width and length in one piece. It is supported by a grid pattern of tensioned steel straps installed below the purlins or joists. This creates the required space for full insulation thickness between the structural members. In multi-layer systems the upper layer of unfaced insulation may be installed over the structural members with minimal compression.

Common Roof Structures In Which The System May Be Used

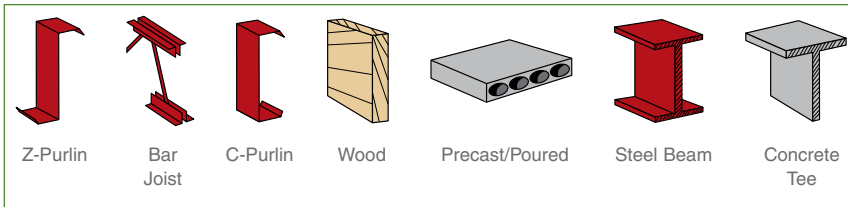

Production Rates

The Simple Saver System is designed for rapid topside installation and optimum insulation performance with 80% fewer field seams. The production rates below are conservative ranges for installation of a single or double-layer system in typical purlin roofs under average conditions with an experienced crew.

Roof: 150-200 sq. ft./man-hour

Walls: 120-170 sq. ft./man-hour

In the summer of 2008, Thermal Design commissioned a third party time study which concluded **production rates of over 235 sq. ft./man-hour**. This equates to less than 25 cents per sq. ft. installation labor costs based on a \$50 per hour labor rate. Contact Thermal Design for time study details.

Simple Saver [®] Roof Systems		
Pre-installed R-value	Lower Layer(s)	Upper Layer(s)
R-19	6"	-
R-25	8"	-
R-29	6"	3"
R-30	9"	-
R-30	6"	3 1/2"
R-32	6"	4"
R-35	8"	3"
R-38	8"	4"
R-43	9"	4"
R-49	9"	6"
R-49	12"	3 1/2"
R-52	12"	4"
R-57	12"	6"
R-60	9"	9"
R-68	12"	9"
R-76	12"	12"

Multiple layers and appropriate space is required for any of these systems.



Install the longitudinal and traverse steel strapping to create the strap platform.



Large custom-sized fabric liner installs quickly on the steel strap platform.



View of fabric liner positioned on strap platform and fastened to the structure.

Performance Comparisons of R-30 Systems

Values are based on insulation assemblies in a 5' purlin space with a standing seam roof and thermal block. The hot box tested assemblies were tested in the horizontal position with vertical upward heat flow. Performance will vary with structural spacing and assembly orientation. Visit www.thermaldesign.com for more information.

A. ASTM-C 1363 hot box tests, Oak Ridge National Laboratory

B. Finite Element Modeling, NAIMA MB304 (8/06), System 3

Pre-Installed R-value:

U-value:

Installed R-value:

Simple Saver "Liner System"

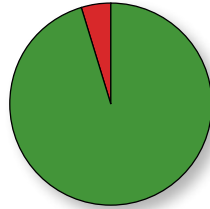
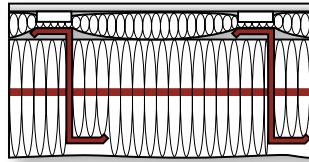

4.7% loss

R-30 (R19+R11)

U-0.035^A

R-28.6

Long Tab System "Filled Cavity"

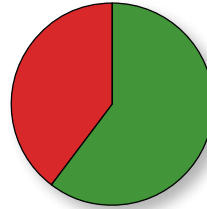
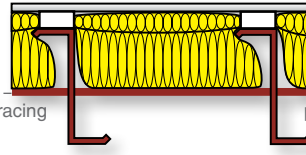

39.7% loss

R-29 (R19+R10)

U-0.057^B

R-17.5

Sag & Bag "Double Layer"

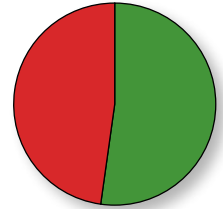
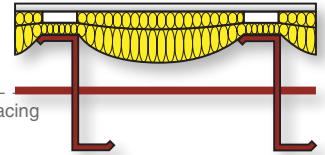

47.0% loss

R-30 (R19+R11)

U-0.063^A

R-15.9

Items to consider when ordering buildings.

Standardized Purlin Spacings

Custom made insulation widths are available however, by simply specifying or requesting standardized purlin spaces from the building manufacturer, you will increase your installation productivity, reduce waste and shorten lead times for delivery. **Specify 3', 4' and 5' purlin spacings from the building manufacturer that match standard insulation widths.** There is no reason why there should be more than one non-standard width spacing on each side of the ridge of any building.

Rafter Brace Clips

The design of the rafter brace attachment to the bottom plane of the purlin speeds installation of the liner system and provides superior vapor seal. **Specify one of these common details when ordering your building.**

Hanging Methods

These are some of the many common hangers that can be used with the Simple Saver System without the need to cut the fabric liner. Compression seals or caulk type sealants may be used with any hanger type. Contact Thermal Design at **800-255-0776** for additional hanger details or sourcing.

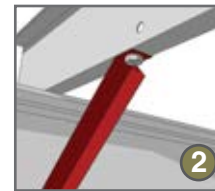
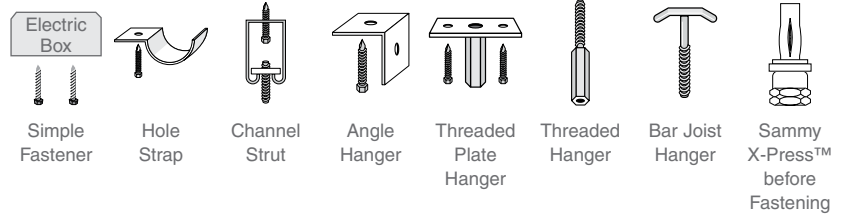

Clips now available in white or black!



Fabric liner trimmed and sealed to the rafter.



Install JM Formaldehyde-free™ fiber glass insulation between and over purlins.



Finished ceiling and wall system in school gymnasium.

Metal Building Wall Detail

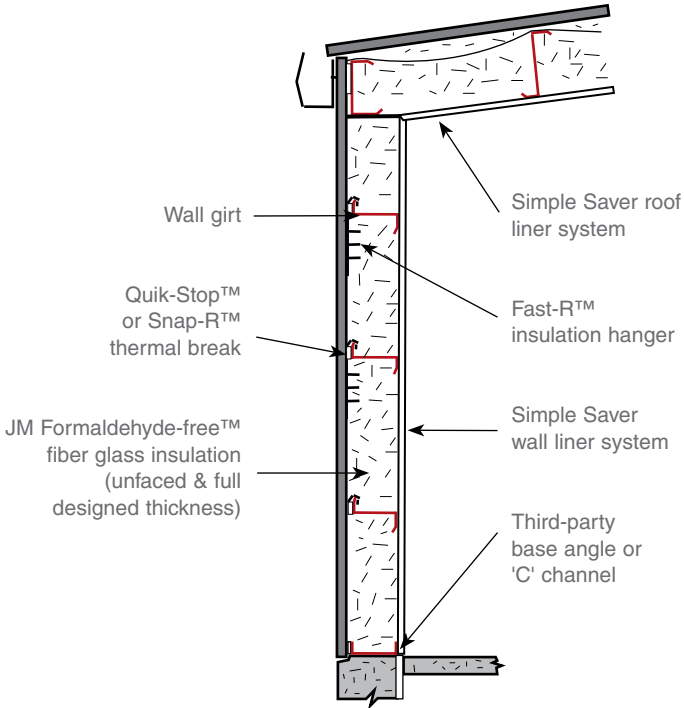

Metal Building Wall System

The Simple Saver wall insulation system is installed completely from the inside, out of the wind and weather. Unfaced insulation lengths are simply cut to fit the girt spacings and then impaled onto Fast-R® insulation hangers. This prevents the fiber glass from sagging. The fabric liner is then installed on the inside plane of the wall to isolate the insulation and conductive girts from the conditioned air. This also provides a clean, bright, finished appearance.

Filling The Full Girt Depth Is Required

Single layer systems help speed the wall sheathing process and a thick single layer of unfaced insulation is preferred to two layers of compressed laminated insulation in walls. The Simple Saver single layer liner systems prevent bulging and dimpling of the metal wall panels which is common with laminated insulation compressed between the panels and through-fastened to the sub-structure.

The full depth should be filled to minimize loss of thermal performance caused by convection currents. Wall panel laps, trim and flashing should be sealed per codes to prevent air infiltration into the insulation. Syseal Building Wrap™ is also available for the ultimate in air leakage resistance.

The Simple Saver insulation system installs in virtually any wall structure type to make any building envelope energy efficient.

Quik-Stop™ Thermal Break



Insulative foam thermal break with adhesive back. Recommended between metal wall panels and metal sub-structure with single layer insulation systems.

Minimizes thermal conduction between metal wall panels or decking and the metal sub-structure.

108' long x 3" width x 3/16" thick

Fast-R™ Wall Insulation Hanger



Preformed and punched Fast-R hangers attach to the girts or wall surfaces.

These save time and hold the insulation in permanent position.

Packed 80 hangers/ box, 32" long x 1" wide, 20 Gauge

One box covers approximately 1,000 sq. ft.

Snap-R® Thermal Block



Individual "snap-on" EPS thermal blocks save installation time and will not blow away with the wind.

24" long x 4" wide x designed thickness.

Standard above flange thicknesses are 3/8" and 1" thick which accommodates a 3" purlin flange. Other thicknesses are available to create the required space for any desired insulation thickness to fully expand!



Quik-Stop™ thermal break tape applied to outside of girts.



Secure the Fast-R™ insulation hangers to the wall structure with the punched arrows bent 90 degrees from the vertical.



Insulation is cut to fit the full space and impaled on the Fast-R™ hangers.

The Simple Saver System[®] may be installed in a variety of common wall structures.

*Flat surfaces require stand-off brackets

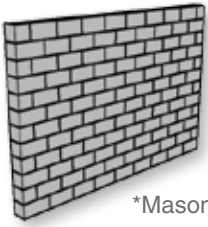

*Masonry

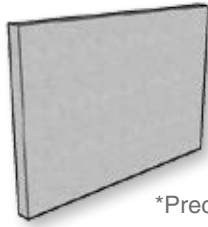

*Precast concrete



Wood or steel stud

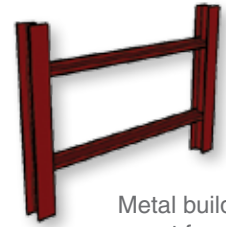

Metal building or post frame wall

Hard Wall Detail

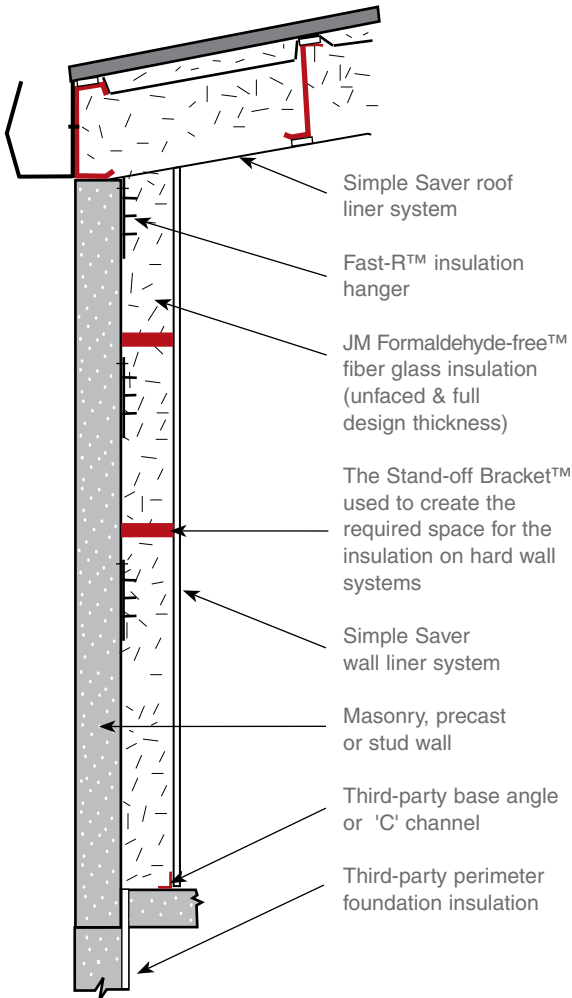

Stand-off 'Z' Brackets™

Brackets are purchased separately and include fasteners. Other sizes available.

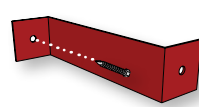

Stand-off Bracket System for Hard Walls (conditions may vary).

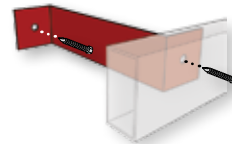

Stand-off Bracket shown with optional steel or wood girt attached. Girts are required for the attachment of optional protective liner panels.

Simple Saver [®] Wall Systems	
Preinstalled R-Value	Thickness
R-10	3"
R-11	3 1/2"
R-13	4"
R-19	6"
R-25	8"
R-30	9"
R-38**	12"

**Two insulation layers and stand-off brackets may be required to provide necessary insulation depth.

Other combinations are available upon request.

Installed performance is currently under study and indicate up to a 50% reduction of installed performance in vertical orientation using typical low density fiber glass metal building insulation.

Call Thermal Design at 800-255-0776 for analysis of your specific application.

Liner Panel

Optional steel or plywood wall liner panels protect the bottom of the wall fabric liner system.



JM Formaldehyde-free™ fiber glass is full thickness and fills the girt depth.



Fabric liner with steel straps installed to create clean, finished look.



Finished wall and ceiling in manufacturing facility.

Common Uses



Put our
experience to
work for you.

Over 40,000
installations
since 1983.



The Simple Saver System[®] is ideal
for finishing and insulating buildings of
all applications.

Call 800-255-0776 for free design and
specification assistance.

Many Buildings and Uses

Gymnasiums & Arenas

Tennis Facilities

Indoor Ice Rinks

Equestrian Centers

Manufacturing Facilities

Warehouses

Transportation Centers

Distribution Facilities

Fire & Emergency

Schools & Universities

Worship Facilities

Community Centers

Aviation H

Agricultural

Wine

Detention



One Insulation System

Hangars
Buildings
Aerodromes
Centers

Retail Stores
Offices
Big Box Stores
Vehicle Showrooms

Convention Centers
Casinos
Entertainment Venues
Theaters

Municipal Buildings
Federal & State Facilities
Military Facilities
Public Works & Recycling

Retrofit Roof & Walls



Before

Compressed insulation results in poor thermal and acoustical performance.

The vapor retarder faced insulation is compressed over the tops of the purlins which typically are seasonally below the dew point temperature resulting in condensation, corrosion and shortened roof life.

Purlins and girts act like fins on a radiator. In the winter heat escapes the building and in the summer, heat radiates into the building.

The exposed structure absorbs light and casts shadows requiring unnecessary lighting.

Stapled facing seams have opened up and the vapor retarder facing has cracked and ripped, allowing moisture to reach the conductive metal deck panels.

The building has an unfinished appearance, compressed insulation and conductive structure is exposed to the conditioned air.



After

Added insulation greatly increases thermal performance and acoustic absorption.

The vapor retarder is properly placed below the purlins to help prevent condensation and corrosion which extends the life of the roof.

Purlins and girts are completely covered by the Simple Saver fabric liner system which also encapsulates the insulation space.

The fabric liner system is designed to have excellent light reflectivity and diffusion with the purlins and girts fully covered.

The one piece, triple extrusion welded seam vapor retarder fabric is a high strength, durable fabric liner that holds up to the abuse inside the building and is washable.

Retrofitting with the Simple Saver System will provide a clean, bright finished appearance, maximize insulation performance and isolate conductive structure from the conditioned air.

Thermal & Acoustical Performance

Vapor Retarder Placement

Heat Transfer

Light Reflectivity

Durability & Maintenance

The Choice Is Simple

A 50% savings of conditioning costs is common by retrofitting with the Simple Saver System®.



Install steel strap platform and the fabric liner across the bay.



Pull or blow-in JM Formaldehyde-free™ fiber glass insulation between the purlins.



Fasten and seal the fabric liner edge to the rafter.

The Retrofit Simple Saver System[®] can be installed in virtually any roof or wall structure.

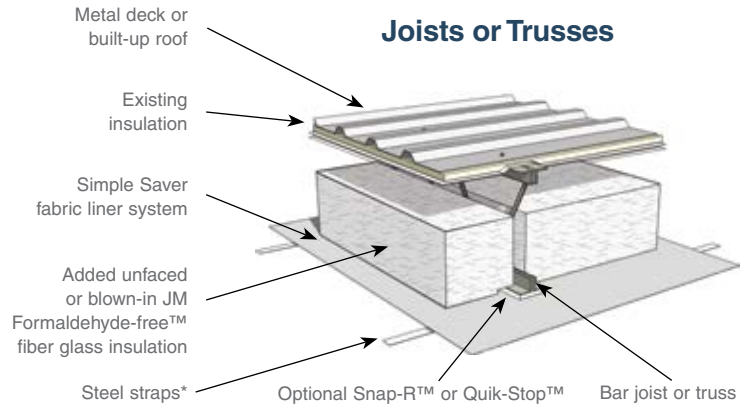
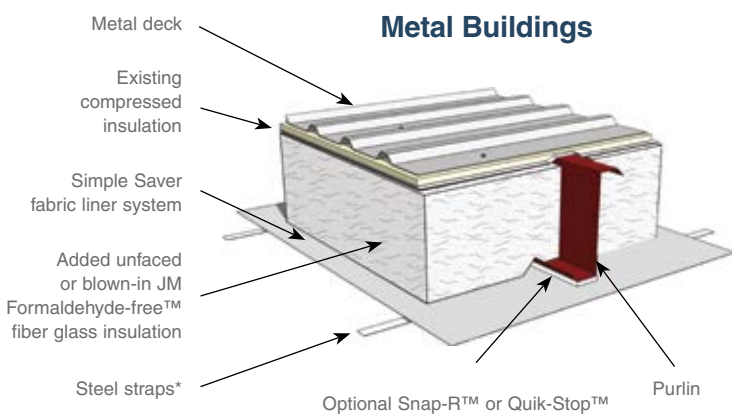

*Standard retrofit strap pattern is one direction, 30-inches on-center. Retrofit grid pattern system also available for small additional cost.

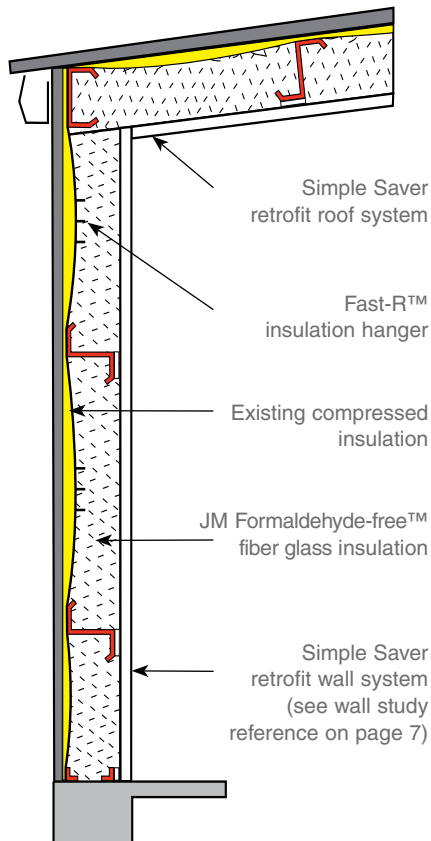

Install Today, Save Tonight

Most existing commercial and industrial buildings have obsolete energy systems for today's higher energy costs. Pre-engineered metal buildings are particularly obsolete because of the poor insulation methods which compress the insulation and leave the conductive steel purlins and girts exposed. Retrofitting with the Simple Saver System and JM Formaldehyde-free[™] fiber glass insulation will start saving immediately and dramatically enhance the interior appearance. Tax deductions may apply.

Advanced Installation

Significantly higher production rates are achieved if the Simple Saver System is installed before other trades (plumbing, electric, heating). The system can also be installed after those trades have completed however the installation is more time consuming and will be more expensive.

R-Value of Existing Compressed Metal Building Insulation		
Pre-Installed R-Value	U-Value	Insulation + Structure R-value
R-10 (3")	U-0.184	R-5.4
R-13 (4")	U-0.174	R-5.8
R-19 (6")	U-0.151	R-6.6

Based upon purlin spacing 60" on-center with faced insulation compressed between the structure and the through-fastened steel panels. Based on proposed ASHRAE 90.1-2007 Addendum bb.

Retrofit Roof Systems

R-Value of added insulation subject to space available. Higher values are available upon request.

Insulation Thickness	Added Pre-Installed R-Value
3"	R-10
3 1/2"	R-11
4"	R-13
6"	R-19
8"	R-25
9"	R-30

The values shown above are the values of the added Simple Saver System insulation thickness. For a total insulation value, add the R-value of the retrofit insulation system to the existing installed performance. The performance of retrofit systems varies and minor performance adjustments will be required for conductive structures estimated to be about 10%.



- Lowers Energy Costs to 50% or More
- Improves Interior Appearance
- Increases Light Levels with White Liner System
- Helps Prevent Condensation
- Increases Thermal Efficiency
- Creates Quiet Interiors with Acoustic Absorption
- Prevents Corrosion and Extends Roof Life
- Seals Off Dust-Collecting Structure
- Lowers Maintenance Costs

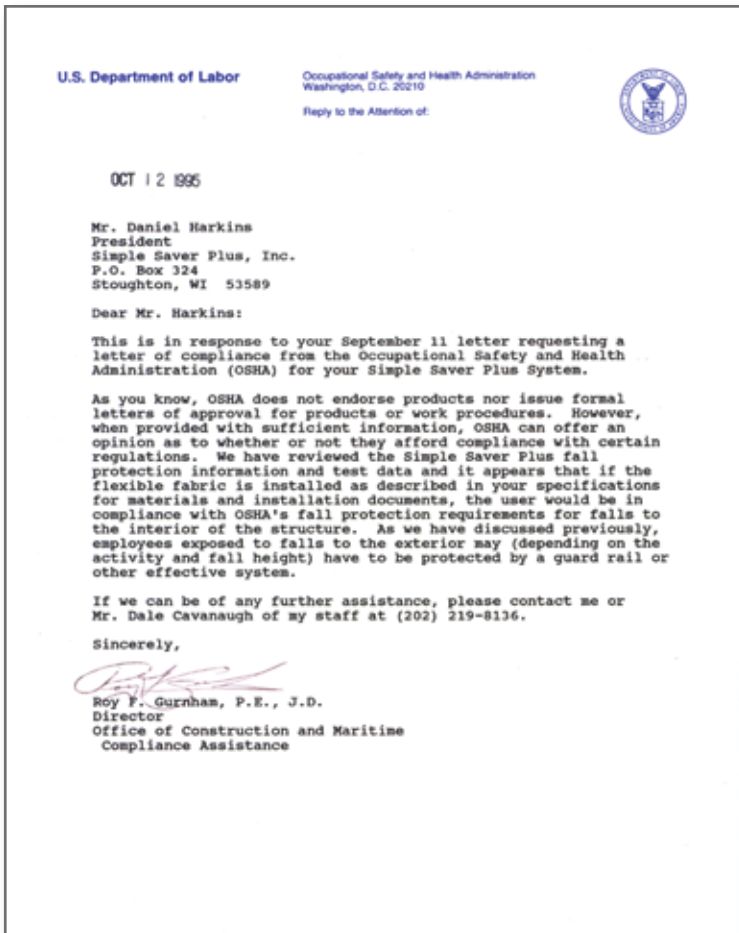

OSHA Steel Erection Standard

On January 18 of 2001, the new steel erection standard was published in the Federal Register. The new standard requires full fall protection for steel erectors and insulators at heights greater than 15 feet. This rule became effective July 18, 2001 (www.osha.gov). Owners, architects and upline contractors are potentially liable for compliance of workers on projects under their control (Standard 29 CFR Definitions–1926.751 "Controlling Contractor"). The Federal Registry, Vol. 66 No. 12 states that:

"A controlling contractor is an entity that has general supervisory authority over the work site such that it can correct safety and health violations itself or have others correct them."

In the past, steel erectors and insulators were exempt on buildings of 25 feet or less. The revised rule requires full fall protection greater than 15 feet in height. The consequence is that most buildings are no longer exempt from fall protection compliance. Workers are required to tie off or use alternative means of fall protection, resulting in a significant loss of productivity. The patented Simple Saver System solves this problem and dramatically increases productivity by providing passive fall protection.

The Simple Saver System® offers free OSHA compliant, alternative fall protection for new pre-engineered metal building purlin roof systems. Perimeter protection within six feet of any edge is required using safety harness and lanyard. Thermal Design has tested the system as instructed by OSHA and the system has passed the stringent test.

The complete Simple Saver System including insulation can be installed for approximately 25 cents per sq. ft. labor costs. Go to www.thermaldesign.com to review the third party time study.

"Ask for it by Name, Rely on it for Safety"

Patented Fall Protection

The Simple Saver Liner System quickly installs from lifts and the workers are then safe to work from above without the need to be restrained by cumbersome lanyards or restricted to controlled decking zones. Effective January 1st of 2001, Thermal Design added the patented fall protection as a **free standard feature of the Simple Saver System at no additional cost**. The Simple Saver System requires two critical strap end fasteners to safely pass the test and achieve safe fall protection.



Custom Project Drawings and Instructions

Detailed, custom project drawings are standard for each building. Specific strap and fastener locations, bay spacings, fabric sizes and exact insulation sizes and placements are all provided for the Simple Saver System to achieve a safe effective installation.



Training & Technical Support

Reduce your liability, keep installers safe and speed up your construction time. Contact us for specifications, design manuals, installation instructions and training videos.

On site installation and safety training is also available. Contact Thermal Design for details at **800-255-0776**.

Energy Code Compliant

The Simple Saver Liner System with JM Formaldehyde-free™ fiber glass insulation easily surpasses the most stringent local, state and government code requirements by providing both low U-values and low emissivity values, stopping over 90% of all three types of heat transfer. Thermal Design has commissioned numerous hot box tests which were done in accordance with **ASTM C-1363, "Standard Test Method for the Thermal Performance of Building Assemblies by Means of a Hot Box Apparatus."** Hot box tests, studies, and reports that pertain to the true effectiveness of "traditional" metal building insulation and the Simple Saver System are available upon request. Contact Thermal Design at **800-255-0776** or **www.thermaldesign.com** for test and technical information.



Screw Down Roofs

Screw down roofs can be approximately \$0.50-\$0.75 less expensive than a standing seam roof just considering the material cost. These savings could be invested towards the roof and wall insulation to help offset project costs and still meet today's and tomorrow's stringent code requirements.

The verified performance of the Simple Saver System installed in a screw down roof exceeds all "traditional over-the-purlin" metal building insulation assemblies currently listed in **ASHRAE 90.1, IECC and COMcheck™.**

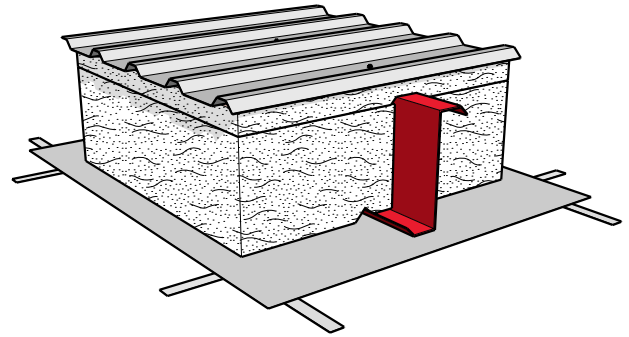

Third party hot box test verify **U-values as low as U-0.0203** can be achieved with the Simple Saver System installed in a screw down roof.

The system will also assist in design goals to earn LEED credits, tax deductions and incentives, and meeting advanced energy efficiency standards such as California's Title 24.

Simple Saver vs. Traditional Methods

With today's high energy costs and the potential for continued increases, owners, designers, builders and the government are all focusing their attention on more energy efficient buildings. **Improving the building envelope design and maximizing your insulation performance will return more value to the owner than any other building material going into the project.** The Simple Saver System is designed to solve the defects of "traditional" compression insulating methods. Properly placing and sealing the liner system to create the full required insulation space will virtually eliminate insulation compression and assure the ultimate performance.



SIMPLE SAVER SYSTEM

- Full Thickness JM Formaldehyde-free™ Fiber Glass Insulation
- Proper Vapor Retarder Placement
- Purlins Fully Encapsulated
- Finished Appearance
- Triple Extrusion Welded Seams
- No Bracing Interference
- Prevents Most Condensation

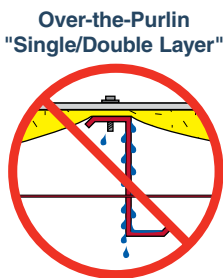

TRADITIONAL METHODS

- Severely Compressed Insulation
- Defective Vapor Retarder Placement
- Voids in Insulation
- Exposed Conductive Structure
- Unfinished Appearance
- Poorly Sealed Seams
- Bracing Interference
- Invites Condensation Problems



LEED Contribution Areas

- Energy & Atmosphere
- Materials & Resources
- Innovation & Design Process
- Indoor Environmental Quality

Commercial Building Tax Deduction

The Simple Saver System can help owners or designers claim a **tax deduction of up to \$1.80 per square foot** for upgrading the envelope, HVAC and lighting that result in 50% savings over the ASHRAE 90.1-2001 Standard. This incentive has recently been extended to 2013. Example: A 20,000 sq. ft. qualified building would yield a \$36,000 tax deduction. Call Thermal Design for assistance with rebates and credits.



EPA'05
Energy Policy Act

It does not have to cost more to build an energy efficient building.

The Simple Saver Synergy Design method reduces costly energy consuming equipment and related costs of traditional construction to pay for energy saving improvements. **The result is an energy efficient building that typically does not cost more to build, but saves money for the lifetime of the building.** Here is how it is done:

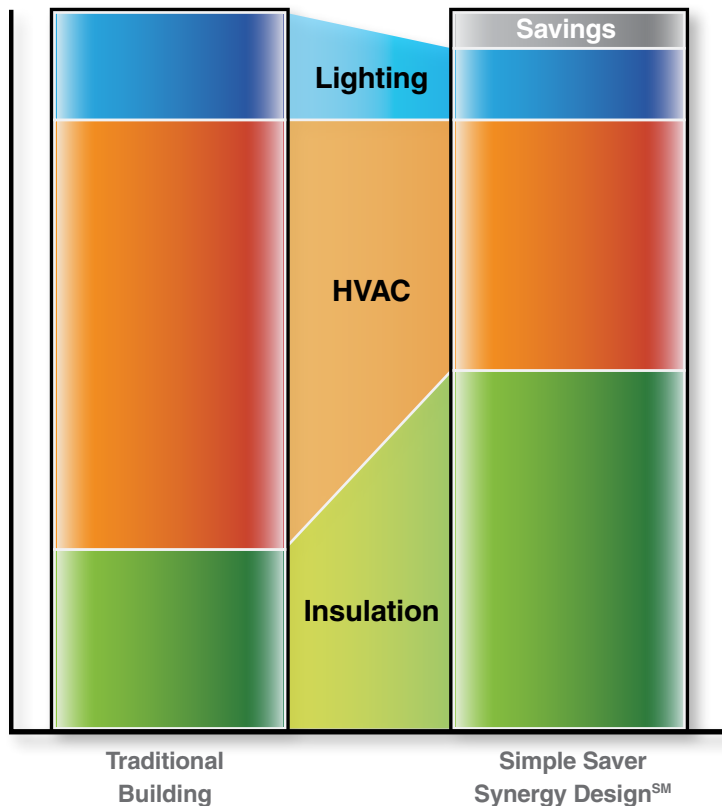

Graph is for illustrative purposes only. Additional savings are available.

Project Cost Trade-offs

In addition to the savings in HVAC and lighting systems, the Simple Saver Synergy Design offers savings in building structure, construction safety, aesthetics, acoustics, finishes and other potential saving areas.

Ownership Savings

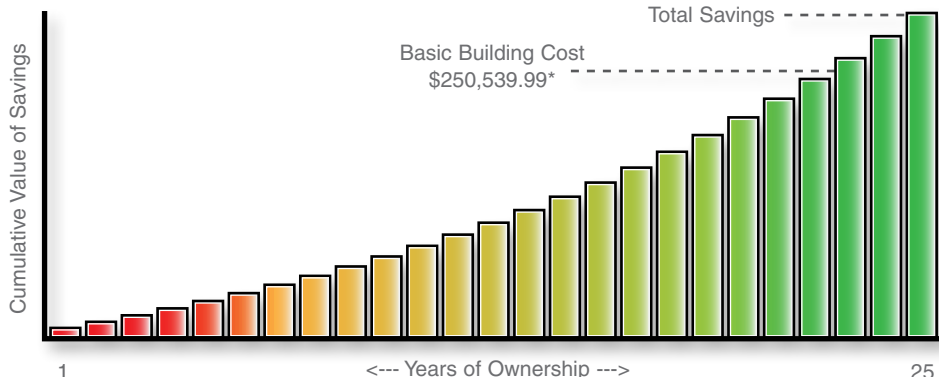

Energy Savings Pay for Basic Buildings!

Not only can energy efficient buildings be built with no added cost compared to traditional metal buildings, the owner saves monthly on energy and maintenance costs. The value of these monthly savings when compared with traditional metal buildings can pay for the building itself.

Call a Synergy Design Expert to discuss potential savings for your project.

*Example calculation for a 10,000 square foot building in Nebraska. Each building is unique and results will vary. Value of savings assume a 2% average yearly increase in energy costs and investing savings at 4.7% yearly rate of return.

Initial Construction Cost for Energy Package

Insulation and Interior Finishing

Super-insulate with the Simple Saver System to control heat loss and gain through the sealed building envelope. The Syseal[®] fabrics' bright white appearance is also used as an exposed interior finish.

HVAC

Reduce HVAC equipment, installation costs and related costs such as gas piping and wiring by adjusting the design due to the superior thermal performance. Use EnergyCraft HVAC appliances to further reduce installation and other costs such as structural, roof curbs, etc.

Lighting

Reduce the number of fixtures, wiring and circuit costs required to reach desired light levels. Reductions up to 30% are achieved because of the high reflectivity of the Simple Saver System. Use high-efficiency EnergyCraft plug-in luminaires to further reduce installation costs.

Incentives

Take advantage of available tax incentives, loans and grants that can further reduce costs when compared with typical construction.

Energy and Maintenance

Save on energy and maintenance costs for the life of the building.

Potential Savings Areas

Through Fall Protection (OSHA compliant)	\$0.20 - \$0.35 / sq. ft.
Painting/Finishing Savings (purlins & girts encapsulated)	\$0.25 - \$0.45 / sq. ft.
Standing Seam Roof Savings	\$0.15 - \$0.75 / sq. ft.
Mechanical Equipment Reductions & Savings	\$0.30 - \$1.00 / sq. ft.
Lighting & Acoustic Treatment Savings	\$0.00 - \$1.00 / sq. ft.
Downsizing Utility Service	\$0.00 - \$1.00 / sq. ft.
Suspended Ceilings, Dry Wall Ceilings and Walls	\$1.50 - \$3.00 / sq. ft.

Call for a FREE Synergy Design Analysis of your upcoming project! New or Retrofit!

Building Cut-away of Simple Saver System[®] and EnergyCraft[®] Energy Efficient Systems

Up to 85% reflective bright white fabric liner

Standard air circulation ceiling fans

Downsized utility service (gas & electric)

EnergyCraft energy efficient heater and air conditioner (wall mounted horizontal appliance shown)

Full thickness JM Formaldehyde-free[™] fiber glass insulation

Quik-Stop[™] thermal break

30% fewer light fixtures

Insulated doors and windows



Wall Mount Horizontal Appliance



Floor Mount Vertical Appliance



EnergyCraft Luminaires

EnergyCraft Appliances

EnergyCraft appliances are pre-fabricated, pre-wired, self contained, "Ready-to-Run" units that simply mount into place and operate when utilities are connected. A framed opening is provided by the contractor during the building erection process. These appliances are designed specifically to work with energy efficient buildings using the Simple Saver System. Thermal Design will provide a quotation for the recommended installation and guarantee the sizing of the equipment for the quoted parameters. A thermostat and cord are supplied with all units. Units may be ducted by third party.

95% high efficiency gas heaters

14 & 16 SEER rated air conditioners

HVAC units are designed as appliances for fast installation

No license normally required for EnergyCraft packaged units

Heat pumps that work to 30° below zero

5 year parts guarantee & lifetime heat exchanger warranty

Appliances are available in a variety of combinations. Choose from various options:

Fuel Source: Gas, Electric or Propane

Unit Type: Package, Split, Cool or Heat only

Orientation: Horizontal or Vertical

EnergyCraft Luminaires

EnergyCraft Octalux[™] & Quintalux[™] high efficiency, high bay fluorescent light fixtures are designed to lower operating costs by about 50% while providing the same amount of light when compared to traditional metal halide fixtures. The 94% efficiency, durable construction and high light output make this one of the most effective investments in your building design.

UL labeled and made in the USA

4 lamp or 6 lamp fixtures available with T5 or T8 lamps

6 foot cord and NEMA certified twist-lock plug

Center mounted ballast

1 year fixture and 5 year ballast warranty

Available Accessories

Ceiling Fans

Exhaust Fans

Intake Louvers

Ventilation Systems

Economizers

Lamp Protectors

Daylight Sensors

Occupancy Sensors

Control Systems

Heat Reclaimers

EnergyCraft Wireless Management Products available soon for even more savings!

Complete Nationwide Service and Distribution Available!

Marketed by Simple Saver Services, LLC:

Each company is responsible only for their respective product claims.

Guarantees, Warranties and Notices

Thermal Performance Guarantee

Please visit www.thermaldesign.com for Thermal Design's Thermal Performance Guarantee.

Ten-Year Limited Materials Warranty

The Simple Saver System[®] has a limited warranty. Thermal Design warrants this product subject to certain conditions and exceptions. Ask the seller for a copy of the warranty. Please visit www.thermaldesign.com for full details regarding Simple Saver System's Ten-Year Limited Materials Warranty.

Notices

Specification values are typical data subject to normal manufacturing variations and are not meant to be guaranteed or limiting specifications. Thermal Design, Inc. reserves the right to improve and change component specifications without notice.

The information and performance values contained in this brochure replace and supersede all other previous documents created and managed by Thermal Design, Inc. This is largely due to recent industry studies, tests and modeling on metal building insulation assemblies and the resulting thermal performance as typically installed.

States and/or jurisdictions may have a variety of insulation regulations. Check for specific details regarding the insulation regulations that apply in your area.

Patents, Trademarks and Licenses

Unauthorized making, using or selling of this patented technology or trademarks or service marks or copyrighted works shall be each subject to a minimum royalty and lost profit per square foot of surface insulated from such unauthorized acts. Sellers of any component with the knowledge or intent that such component is to be used to evade the purchase of legitimate materials from authorized sources shall be held liable as contributory infringers and otherwise as lawful. All costs of collection, including legal fees and costs, shall be sought as damages for unauthorized use and infringement.

Simple Saver System[®], Synergy Design[™], Snap-R[™], Stand-off 'Z' Brackets[™], Quik-Stop[™], Fast-R[™], Syseal[®], Syseal Building Wrap[™], UVMAX[®] and EnergyCraft[®] are trademarks licensed to Thermal Design, Inc and Simple Saver Services, LLC. All trademarks are property of respective parties.

JM Formaldehyde-free[™] fiber glass insulation manufactured by:



Better Living from the Inside Out
1-800-654-3103 | www.specjm.com

JM Warranty Information

The physical and chemical properties of Microlite[®] "L" and PEBS Blanket[™] represent typical, average values obtained in accordance with accepted test methods and are subject to normal manufacturing variations. They are supplied as a technical service and are subject to change without notice. Numerical flame spread and smoke developed ratings are not intended to reflect hazards presented by this or any other materials under actual fire conditions. Check with the Regional Sales Office nearest you to assure current information. All Johns Manville products are sold subject to Johns Manville's Limited Warranty and Limitation of Remedy. For a copy of the Johns Manville Limited Warranty and Limitation of Remedy, and information on other Johns Manville thermal insulations and systems, call 1-800-654-3103.

JM Formaldehyde-free[™] fiber glass insulation, PEBS[™] and Microlite[®] "L" are registered trademarks of Johns Manville, Denver, CO.

Simple Saver System[®] manufactured by:



America's Leading Thermal System Technology
1-800-255-0776 | Available Nationwide and Export
www.thermaldesign.com

Available through your distributor below:

